

# General Purpose Transistors

## PNP Silicon

# 2N4403

ON Semiconductor Preferred Device

### MAXIMUM RATINGS

Rating	Symbol	Value	Unit
Collector–Emitter Voltage	$V_{CE0}$	40	Vdc
Collector–Base Voltage	$V_{CBO}$	40	Vdc
Emitter–Base Voltage	$V_{EBO}$	5.0	Vdc
Collector Current — Continuous	$I_C$	600	mAdc
Total Device Dissipation @ $T_A = 25^\circ\text{C}$ Derate above $25^\circ\text{C}$	$P_D$	625 5.0	mW mW/°C
Total Device Dissipation @ $T_C = 25^\circ\text{C}$ Derate above $25^\circ\text{C}$	$P_D$	1.5 12	Watt mW/°C
Operating and Storage Junction Temperature Range	$T_J, T_{stg}$	-55 to +150	°C

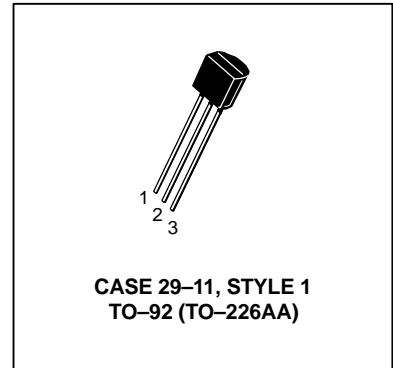

### THERMAL CHARACTERISTICS

Characteristic	Symbol	Max	Unit
Thermal Resistance, Junction to Ambient	$R_{\theta JA}$	200	°C/W
Thermal Resistance, Junction to Case	$R_{\theta JC}$	83.3	°C/W

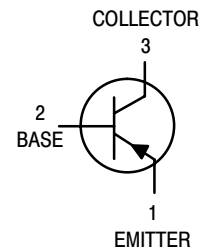

### ELECTRICAL CHARACTERISTICS ( $T_A = 25^\circ\text{C}$ unless otherwise noted)

Characteristic	Symbol	Min	Max	Unit
----------------	--------	-----	-----	------

### OFF CHARACTERISTICS

Collector–Emitter Breakdown Voltage <sup>(1)</sup> ( $I_C = 1.0 \text{ mAdc}, I_B = 0$ )	$V_{(BR)CEO}$	40	—	Vdc
Collector–Base Breakdown Voltage ( $I_C = 0.1 \text{ mAdc}, I_E = 0$ )	$V_{(BR)CBO}$	40	—	Vdc
Emitter–Base Breakdown Voltage ( $I_E = 0.1 \text{ mAdc}, I_C = 0$ )	$V_{(BR)EBO}$	5.0	—	Vdc
Base Cutoff Current ( $V_{CE} = 35 \text{ Vdc}, V_{EB} = 0.4 \text{ Vdc}$ )	$I_{BEV}$	—	0.1	$\mu\text{Adc}$
Collector Cutoff Current ( $V_{CE} = 35 \text{ Vdc}, V_{EB} = 0.4 \text{ Vdc}$ )	$I_{CEX}$	—	0.1	$\mu\text{Adc}$

1. Pulse Test: Pulse Width  $\leq 300 \mu\text{s}$ , Duty Cycle  $\leq 2.0\%$ .

Preferred devices are ON Semiconductor recommended choices for future use and best overall value.

# 2N4403

## ELECTRICAL CHARACTERISTICS (T<sub>A</sub> = 25°C unless otherwise noted) (Continued)

Characteristic	Symbol	Min	Max	Unit
<b>ON CHARACTERISTICS</b>				
DC Current Gain (I <sub>C</sub> = 0.1 mA <sub>dc</sub> , V <sub>CE</sub> = 1.0 V <sub>dc</sub> ) (I <sub>C</sub> = 1.0 mA <sub>dc</sub> , V <sub>CE</sub> = 1.0 V <sub>dc</sub> ) (I <sub>C</sub> = 10 mA <sub>dc</sub> , V <sub>CE</sub> = 1.0 V <sub>dc</sub> ) (I <sub>C</sub> = 150 mA <sub>dc</sub> , V <sub>CE</sub> = 2.0 V <sub>dc</sub> ) <sup>(1)</sup> (I <sub>C</sub> = 500 mA <sub>dc</sub> , V <sub>CE</sub> = 2.0 V <sub>dc</sub> ) <sup>(1)</sup>	h <sub>FE</sub>	30 60 100 100 20	— — — 300 —	—
Collector–Emitter Saturation Voltage <sup>(1)</sup> (I <sub>C</sub> = 150 mA <sub>dc</sub> , I <sub>B</sub> = 15 mA <sub>dc</sub> ) (I <sub>C</sub> = 500 mA <sub>dc</sub> , I <sub>B</sub> = 50 mA <sub>dc</sub> )	V <sub>CE(sat)</sub>	— —	0.4 0.75	V <sub>dc</sub>
Base–Emitter Saturation Voltage <sup>(1)</sup> (I <sub>C</sub> = 150 mA <sub>dc</sub> , I <sub>B</sub> = 15 mA <sub>dc</sub> ) (I <sub>C</sub> = 500 mA <sub>dc</sub> , I <sub>B</sub> = 50 mA <sub>dc</sub> )	V <sub>BE(sat)</sub>	0.75 —	0.95 1.3	V <sub>dc</sub>

## SMALL-SIGNAL CHARACTERISTICS

Current–Gain — Bandwidth Product (I <sub>C</sub> = 20 mA <sub>dc</sub> , V <sub>CE</sub> = 10 V <sub>dc</sub> , f = 100 MHz)	f <sub>T</sub>	200	—	MHz
Collector–Base Capacitance (V <sub>CB</sub> = 10 V <sub>dc</sub> , I <sub>E</sub> = 0, f = 1.0 MHz)	C <sub>cb</sub>	—	8.5	pF
Emitter–Base Capacitance (V <sub>EB</sub> = 0.5 V <sub>dc</sub> , I <sub>C</sub> = 0, f = 1.0 MHz)	C <sub>eb</sub>	—	30	pF
Input Impedance (I <sub>C</sub> = 1.0 mA <sub>dc</sub> , V <sub>CE</sub> = 10 V <sub>dc</sub> , f = 1.0 kHz)	h <sub>ie</sub>	1.5 k	15 k	ohms
Voltage Feedback Ratio (I <sub>C</sub> = 1.0 mA <sub>dc</sub> , V <sub>CE</sub> = 10 V <sub>dc</sub> , f = 1.0 kHz)	h <sub>re</sub>	0.1	8.0	X 10 <sup>-4</sup>
Small–Signal Current Gain (I <sub>C</sub> = 1.0 mA <sub>dc</sub> , V <sub>CE</sub> = 10 V <sub>dc</sub> , f = 1.0 kHz)	h <sub>fe</sub>	60	500	—
Output Admittance (I <sub>C</sub> = 1.0 mA <sub>dc</sub> , V <sub>CE</sub> = 10 V <sub>dc</sub> , f = 1.0 kHz)	h <sub>oe</sub>	1.0	100	μmhos

## SWITCHING CHARACTERISTICS

Delay Time	(V <sub>CC</sub> = 30 V <sub>dc</sub> , V <sub>BE</sub> = +2.0 V <sub>dc</sub> , I <sub>C</sub> = 150 mA <sub>dc</sub> , I <sub>B1</sub> = 15 mA <sub>dc</sub> )	t <sub>d</sub>	—	15	ns
Rise Time		t <sub>r</sub>	—	20	ns
Storage Time	(V <sub>CC</sub> = 30 V <sub>dc</sub> , I <sub>C</sub> = 150 mA <sub>dc</sub> , I <sub>B1</sub> = 15 mA, I <sub>B2</sub> = 15 mA)	t <sub>s</sub>	—	225	ns
Fall Time		t <sub>f</sub>	—	30	ns

1. Pulse Test: Pulse Width ≤ 300 μs, Duty Cycle ≤ 2.0%.

### SWITCHING TIME EQUIVALENT TEST CIRCUIT

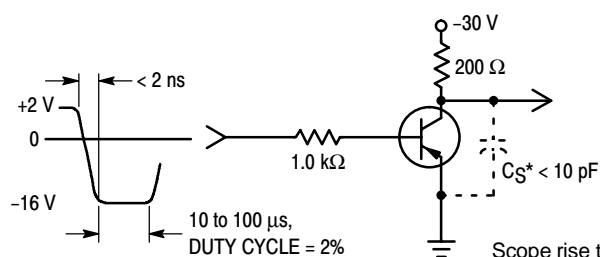

Figure 1. Turn–On Time

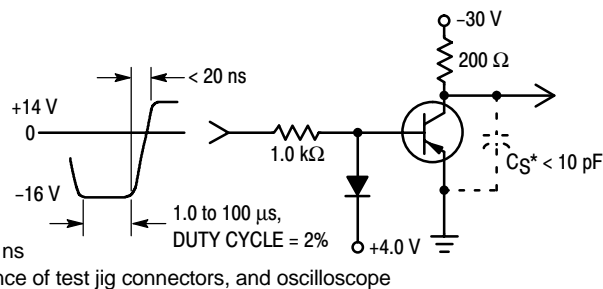

Figure 2. Turn–Off Time

# 2N4403

## TRANSIENT CHARACTERISTICS

— 25°C    - - - 100°C

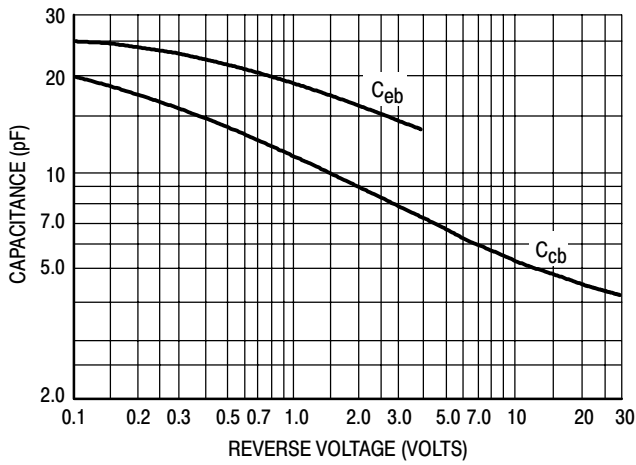

Figure 3. Capacitances

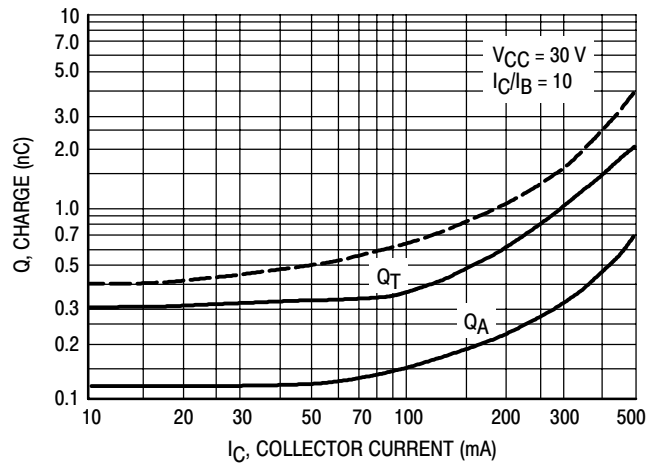

Figure 4. Charge Data

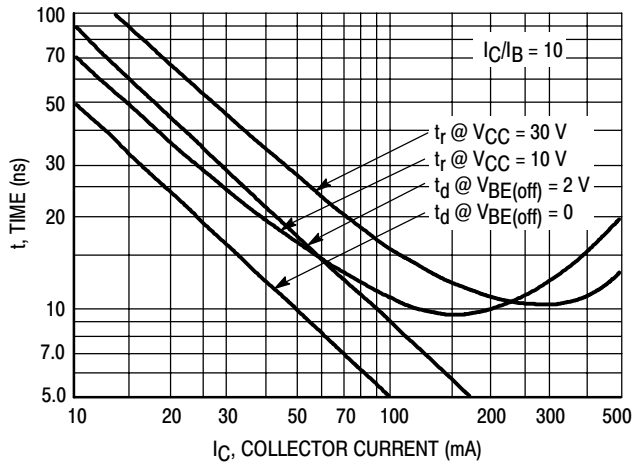

Figure 5. Turn-On Time

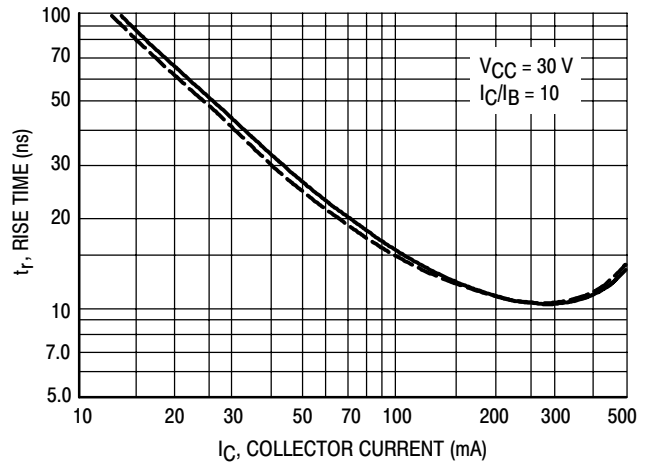

Figure 6. Rise Time

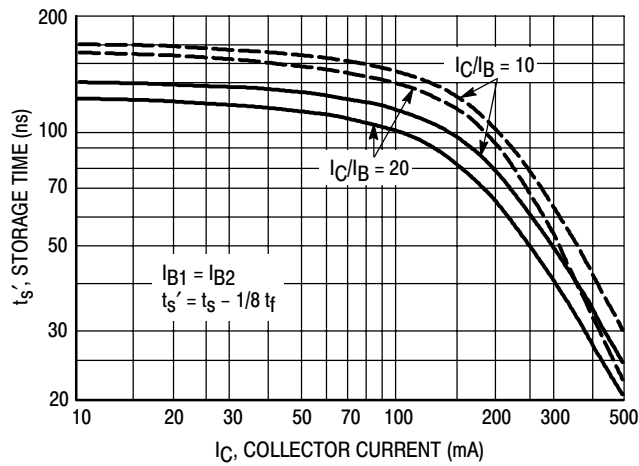

Figure 7. Storage Time

# 2N4403

## SMALL-SIGNAL CHARACTERISTICS NOISE FIGURE

$V_{CE} = -10 \text{ Vdc}$ ,  $T_A = 25^\circ\text{C}$ ; Bandwidth = 1.0 Hz

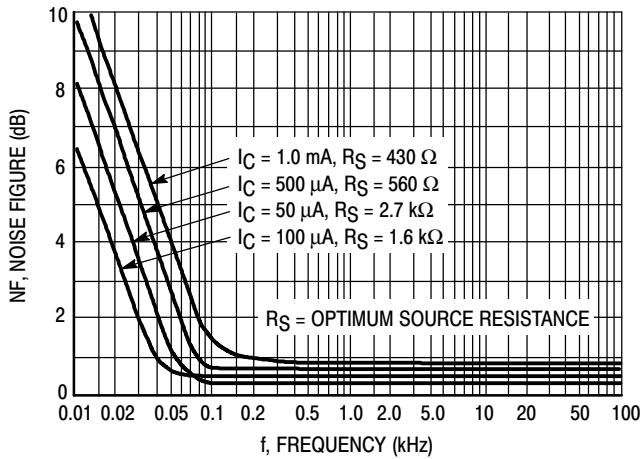

Figure 8. Frequency Effects

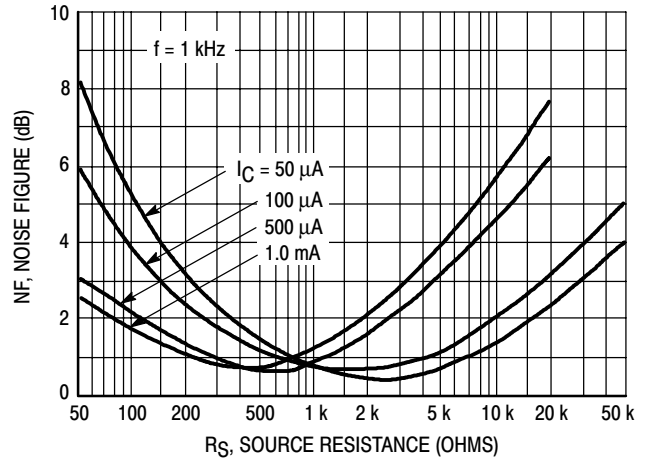

Figure 9. Source Resistance Effects

## h PARAMETERS

$V_{CE} = -10 \text{ Vdc}$ ,  $f = 1.0 \text{ kHz}$ ,  $T_A = 25^\circ\text{C}$

This group of graphs illustrates the relationship between  $h_{fe}$  and other “h” parameters for this series of transistors. To obtain these curves, a high-gain and a low-gain unit were

selected from the 2N4403 lines, and the same units were used to develop the correspondingly-numbered curves on each graph.

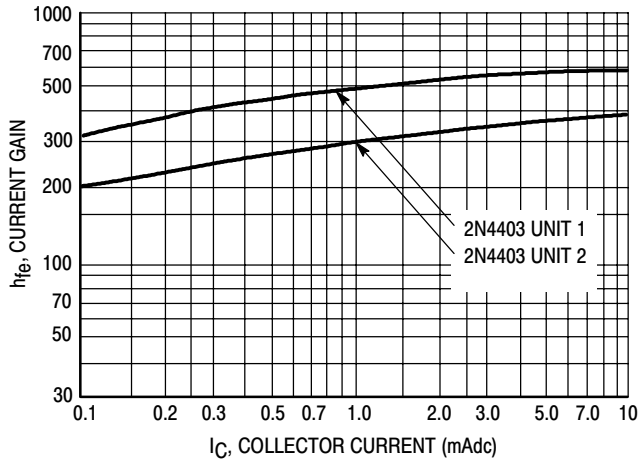

Figure 10. Current Gain

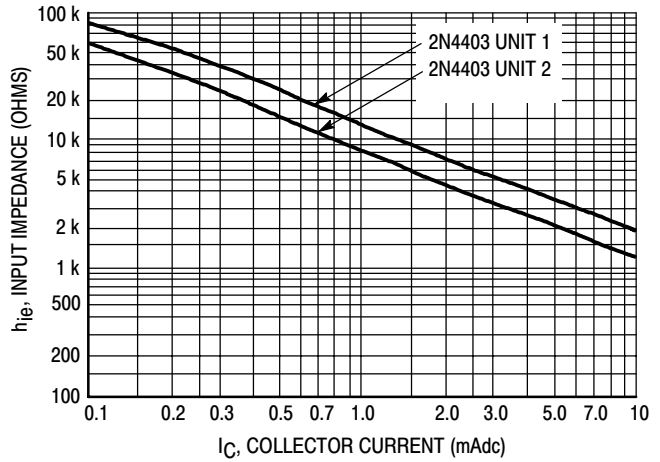

Figure 11. Input Impedance

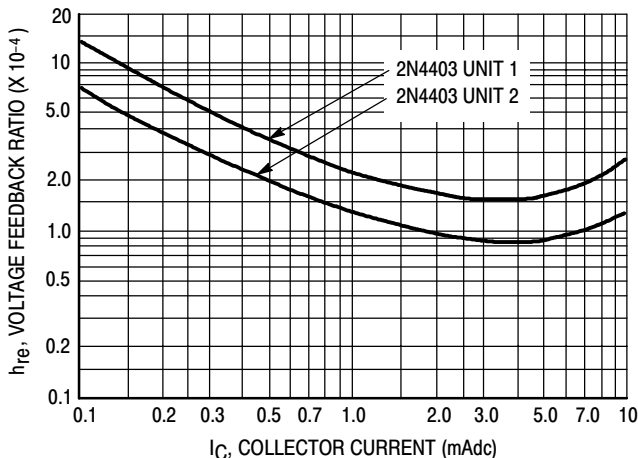

Figure 12. Voltage Feedback Ratio

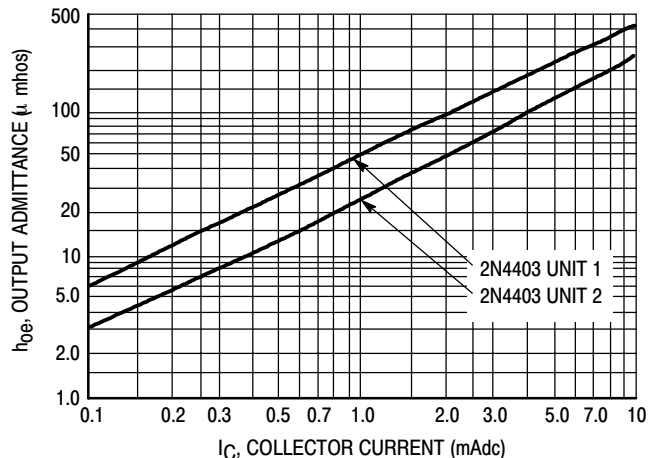

Figure 13. Output Admittance

STATIC CHARACTERISTICS

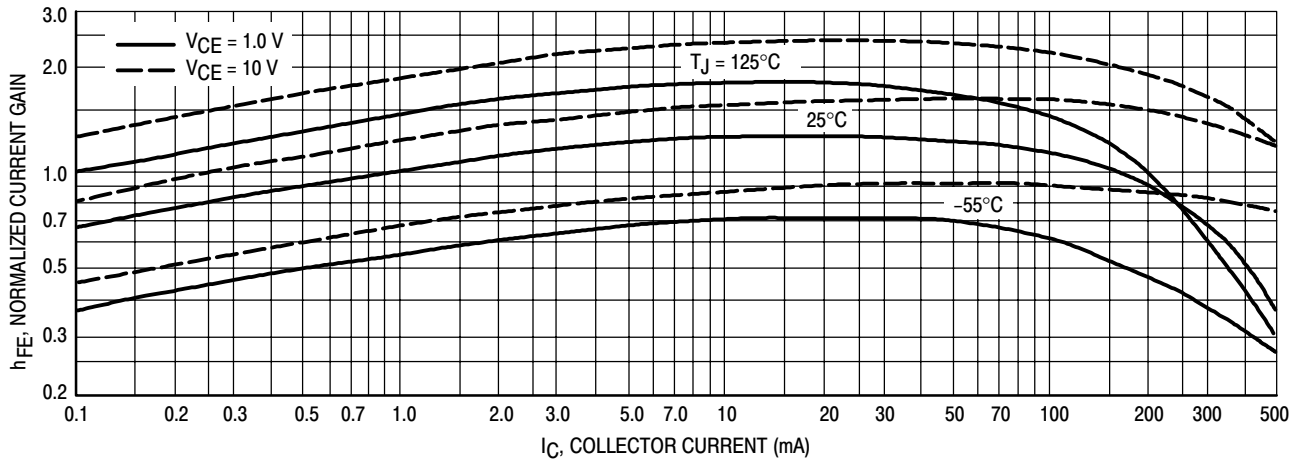

Figure 14. DC Current Gain

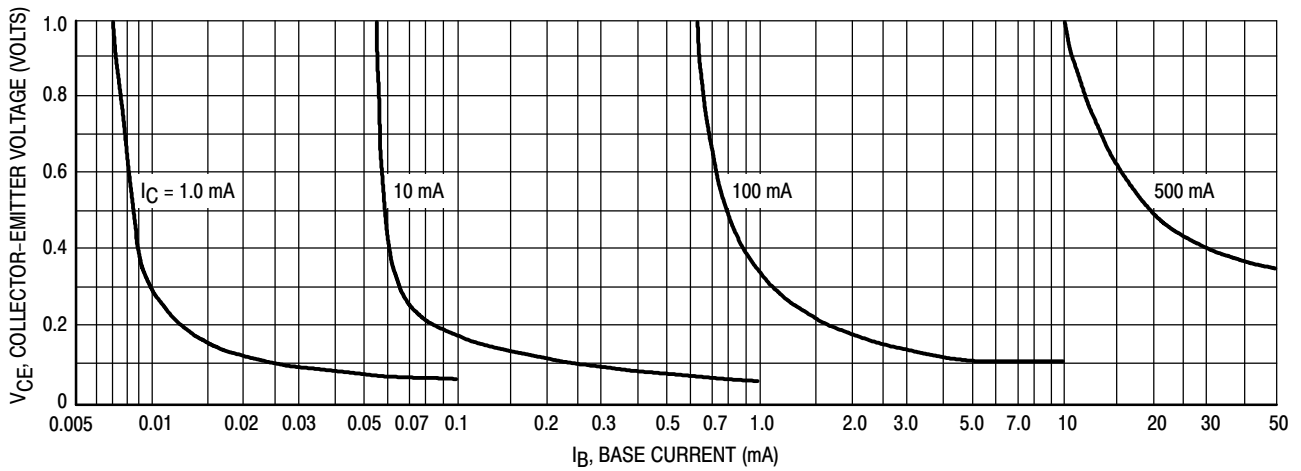

Figure 15. Collector Saturation Region

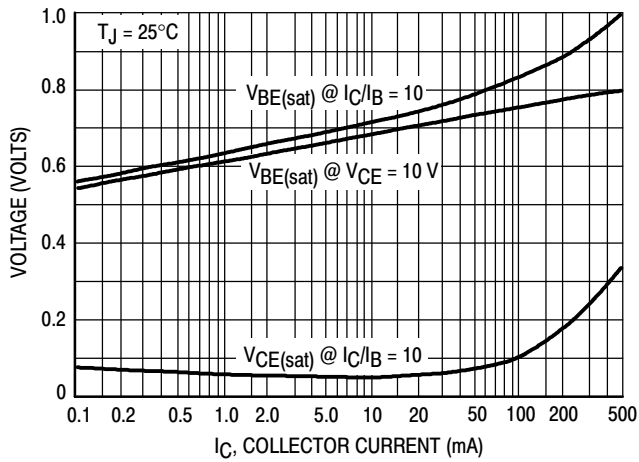

Figure 16. "On" Voltages

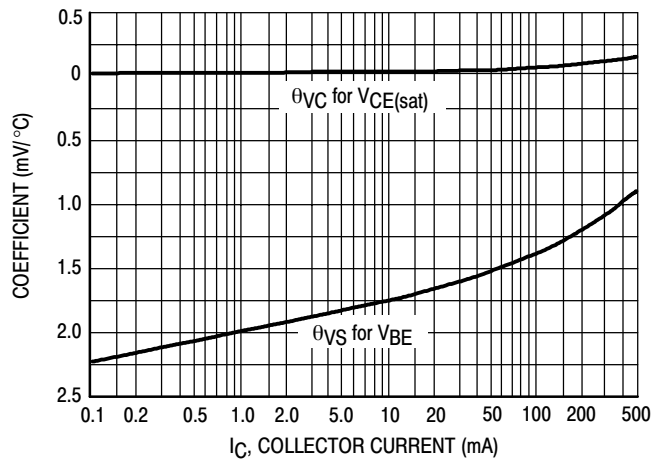
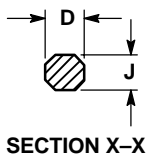
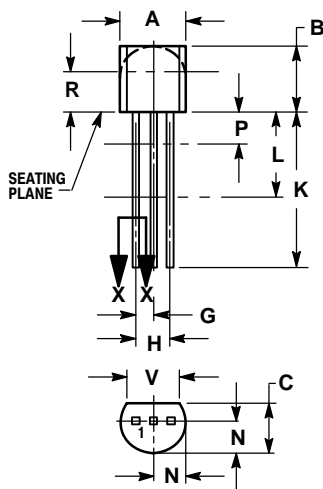

Figure 17. Temperature Coefficients

# 2N4403

## PACKAGE DIMENSIONS

### TO-92 (TO-226) CASE 29-11 ISSUE AL



TYLE 1:  
PIN 1. EMITTER  
2. BASE  
3. COLLECTOR

#### NOTES:

1. DIMENSIONING AND TOLERANCING PER ANSI Y14.5M, 1982.
2. CONTROLLING DIMENSION: INCH.
3. CONTOUR OF PACKAGE BEYOND DIMENSION R IS UNCONTROLLED.
4. LEAD DIMENSION IS UNCONTROLLED IN P AND BEYOND DIMENSION K MINIMUM.

DIM	INCHES		MILLIMETERS	
	MIN	MAX	MIN	MAX
A	0.175	0.205	4.45	5.20
B	0.170	0.210	4.32	5.33
C	0.125	0.165	3.18	4.19
D	0.016	0.021	0.407	0.533
G	0.045	0.055	1.15	1.39
H	0.095	0.105	2.42	2.66
J	0.015	0.020	0.39	0.50
K	0.500	---	12.70	---
L	0.250	---	6.35	---
N	0.080	0.105	2.04	2.66
P	---	0.100	---	2.54
R	0.115	---	2.93	---
V	0.135	---	3.43	---

**Notes**

**ON Semiconductor** and  are trademarks of Semiconductor Components Industries, LLC (SCILLC). SCILLC reserves the right to make changes without further notice to any products herein. SCILLC makes no warranty, representation or guarantee regarding the suitability of its products for any particular purpose, nor does SCILLC assume any liability arising out of the application or use of any product or circuit, and specifically disclaims any and all liability, including without limitation special, consequential or incidental damages. "Typical" parameters which may be provided in SCILLC data sheets and/or specifications can and do vary in different applications and actual performance may vary over time. All operating parameters, including "Typicals" must be validated for each customer application by customer's technical experts. SCILLC does not convey any license under its patent rights nor the rights of others. SCILLC products are not designed, intended, or authorized for use as components in systems intended for surgical implant into the body, or other applications intended to support or sustain life, or for any other application in which the failure of the SCILLC product could create a situation where personal injury or death may occur. Should Buyer purchase or use SCILLC products for any such unintended or unauthorized application, Buyer shall indemnify and hold SCILLC and its officers, employees, subsidiaries, affiliates, and distributors harmless against all claims, costs, damages, and expenses, and reasonable attorney fees arising out of, directly or indirectly, any claim of personal injury or death associated with such unintended or unauthorized use, even if such claim alleges that SCILLC was negligent regarding the design or manufacture of the part. SCILLC is an Equal Opportunity/Affirmative Action Employer.

**PUBLICATION ORDERING INFORMATION**

**Literature Fulfillment:**

Literature Distribution Center for ON Semiconductor  
P.O. Box 5163, Denver, Colorado 80217 USA  
**Phone:** 303-675-2175 or 800-344-3860 Toll Free USA/Canada  
**Fax:** 303-675-2176 or 800-344-3867 Toll Free USA/Canada  
**Email:** ONlit@hibbertco.com

**N. American Technical Support:** 800-282-9855 Toll Free USA/Canada

**JAPAN:** ON Semiconductor, Japan Customer Focus Center  
4-32-1 Nishi-Gotanda, Shinagawa-ku, Tokyo, Japan 141-0031  
**Phone:** 81-3-5740-2700  
**Email:** r14525@onsemi.com

**ON Semiconductor Website:** <http://onsemi.com>

For additional information, please contact your local Sales Representative.